

1651

MAERSK LINE

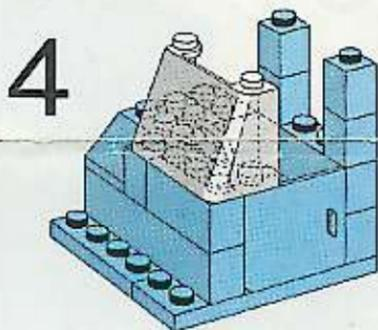

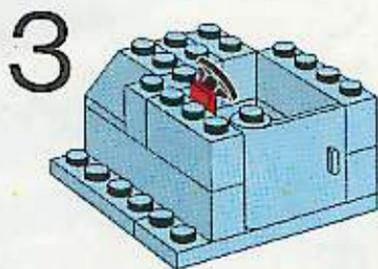
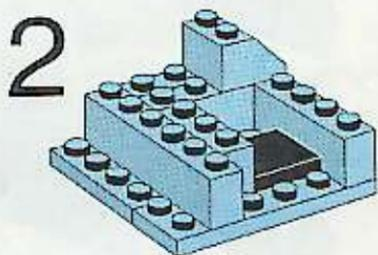
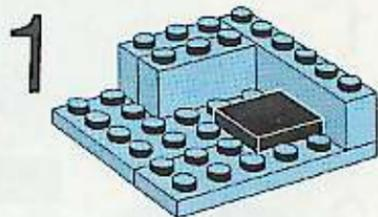
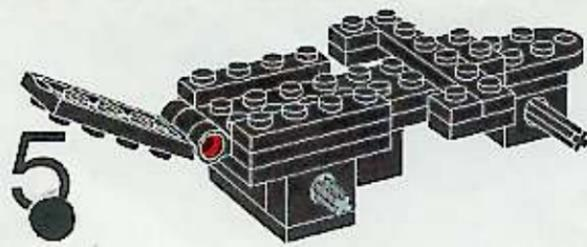
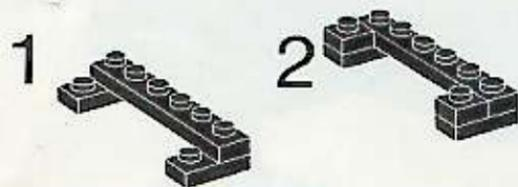
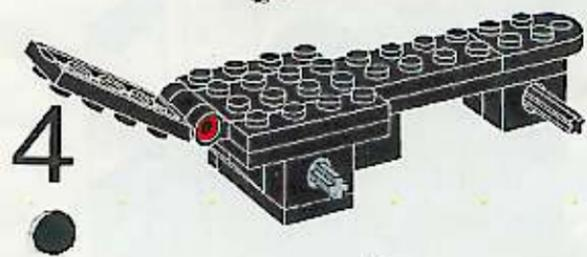
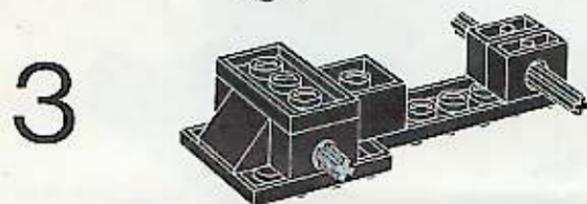
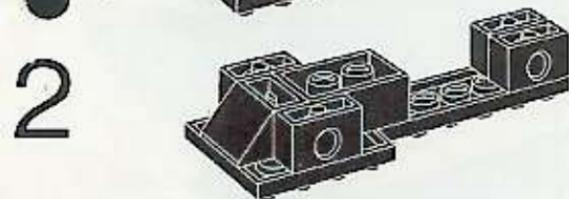

6

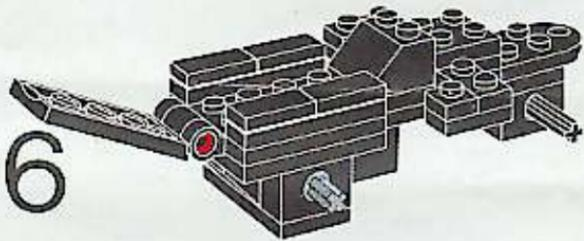

7

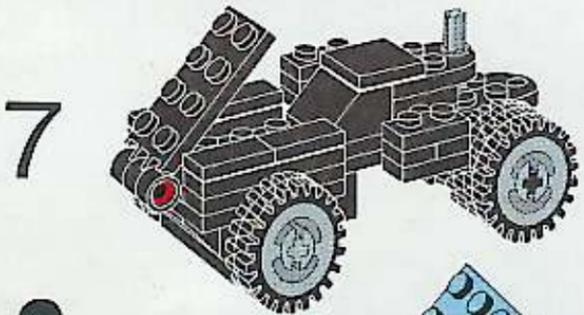

5

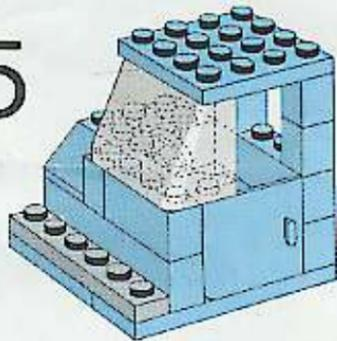

6

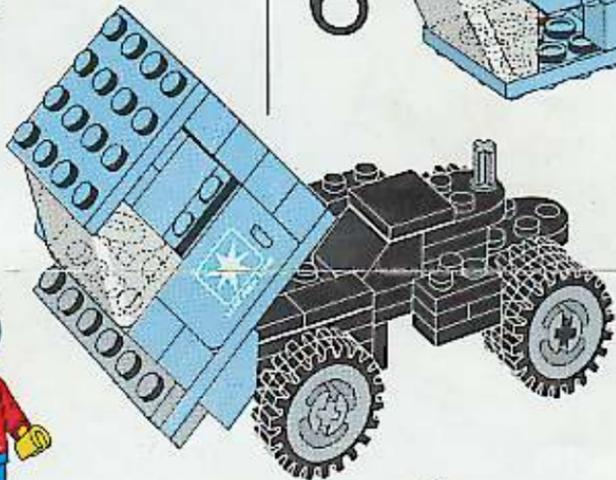
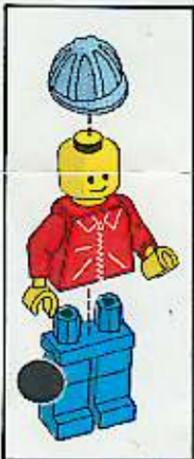
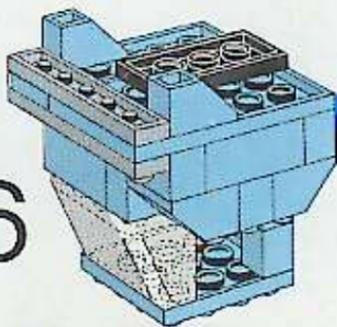

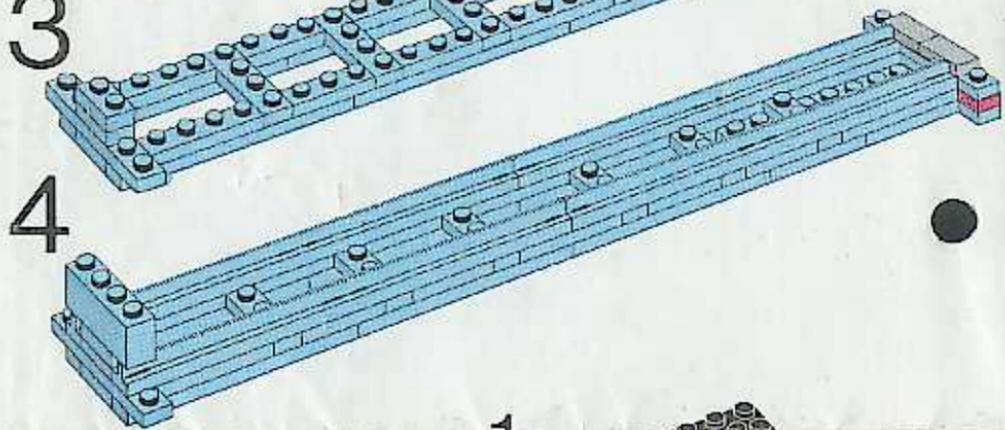
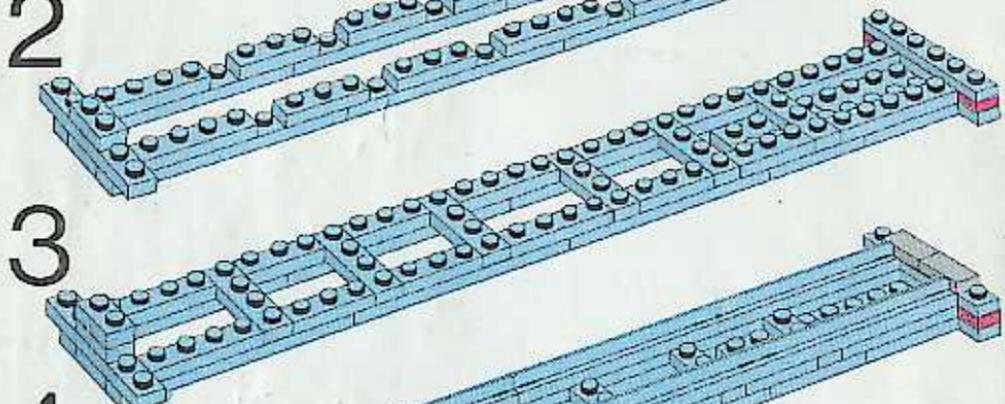
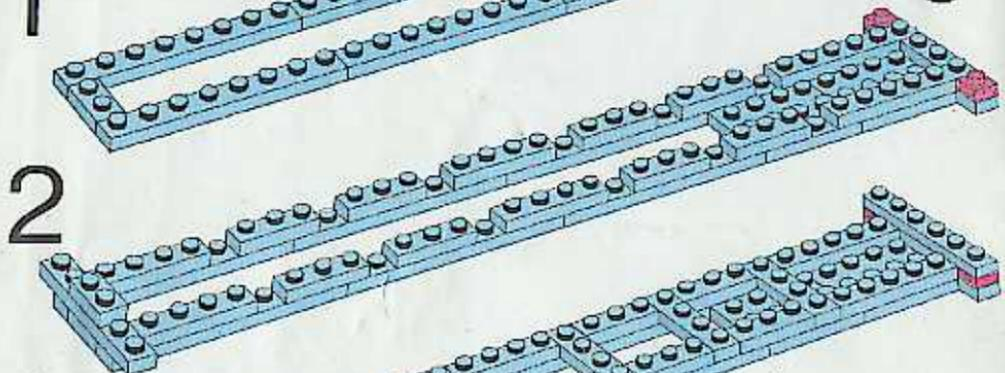
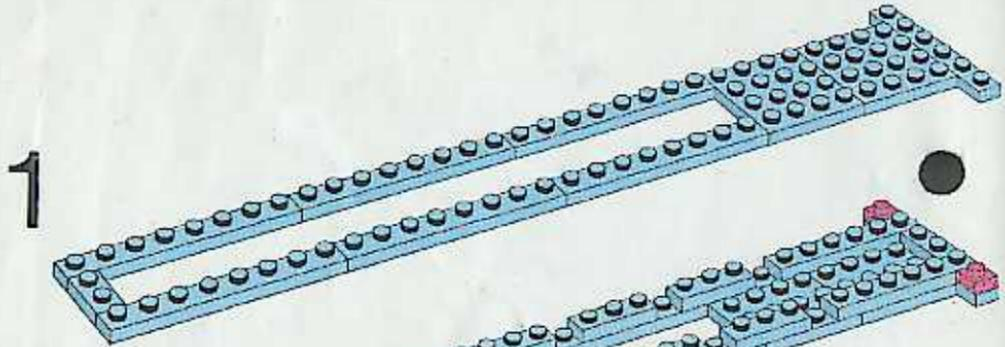

1

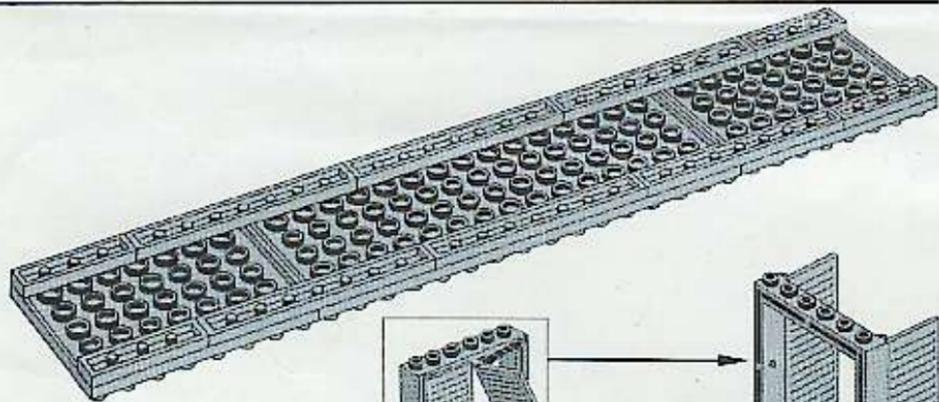

2

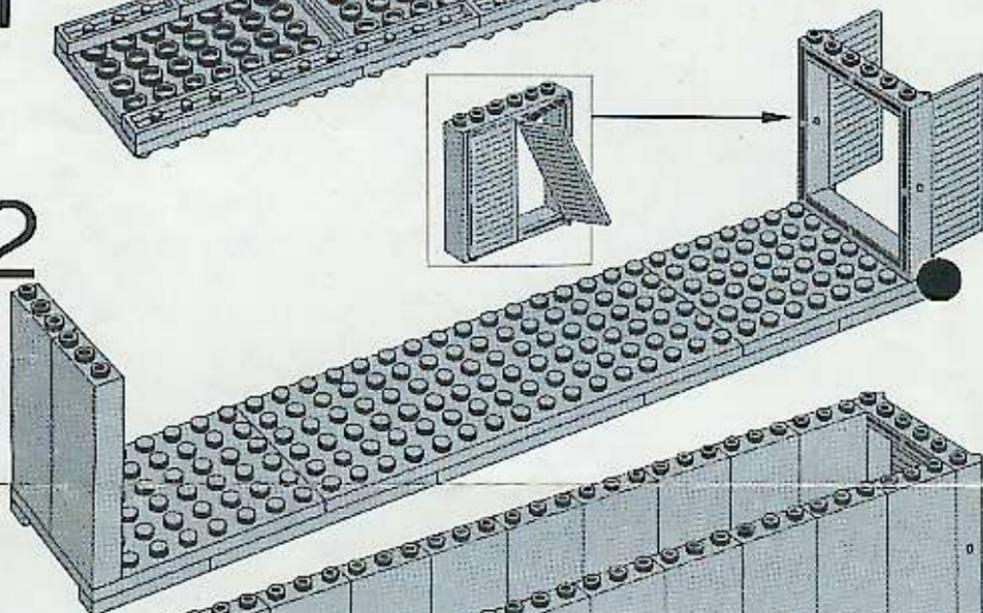

3

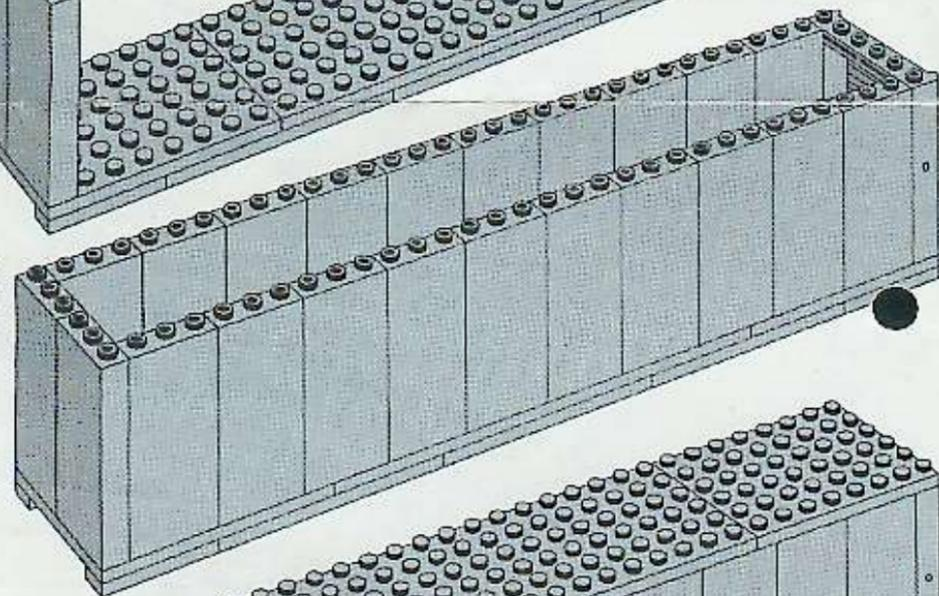

4

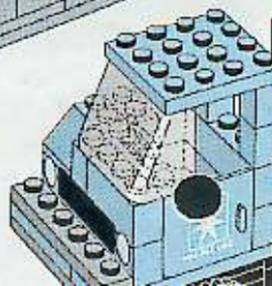
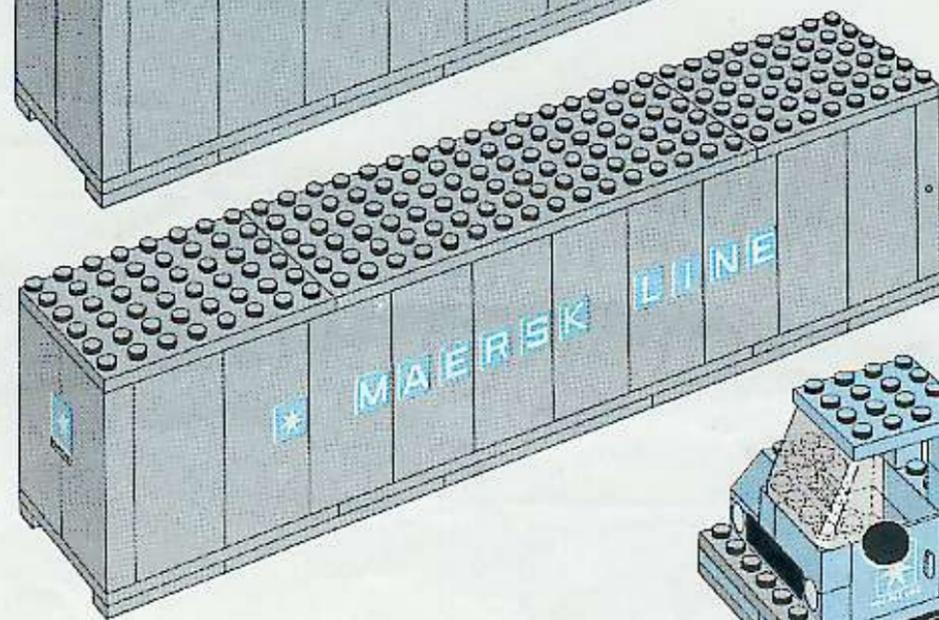

1

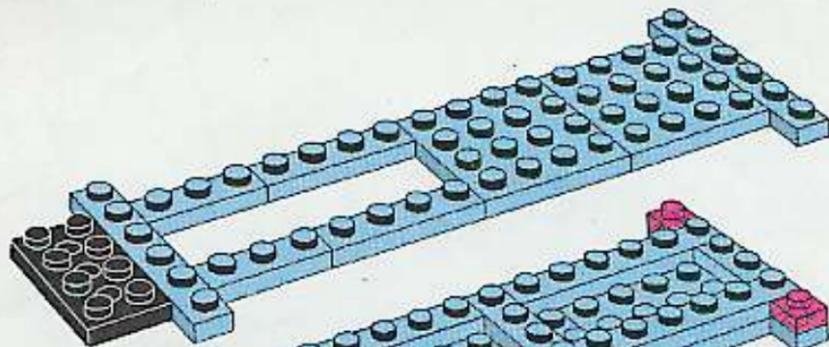

2

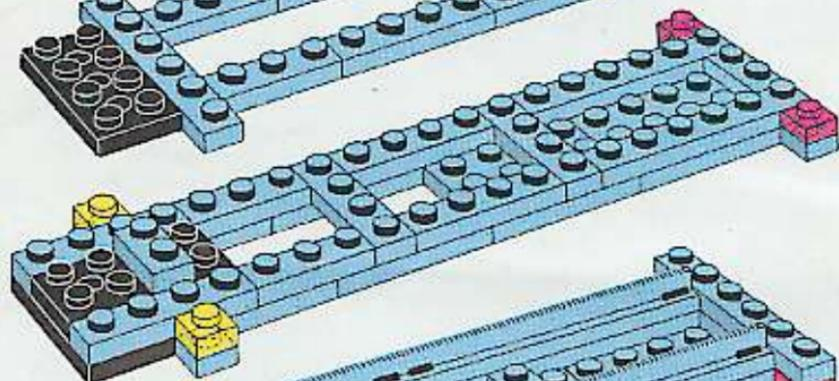

3

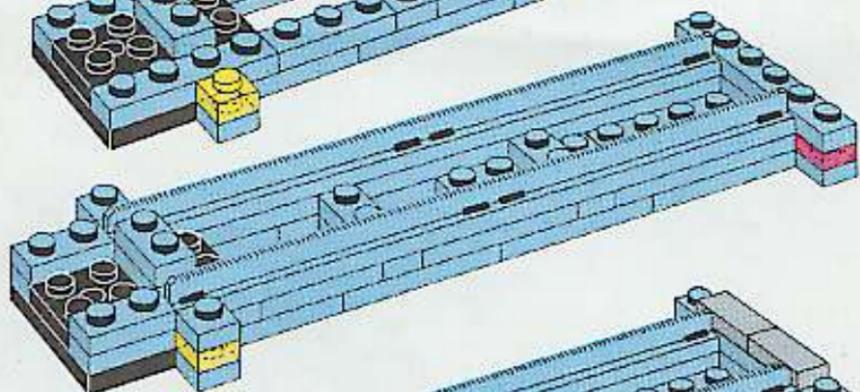

4

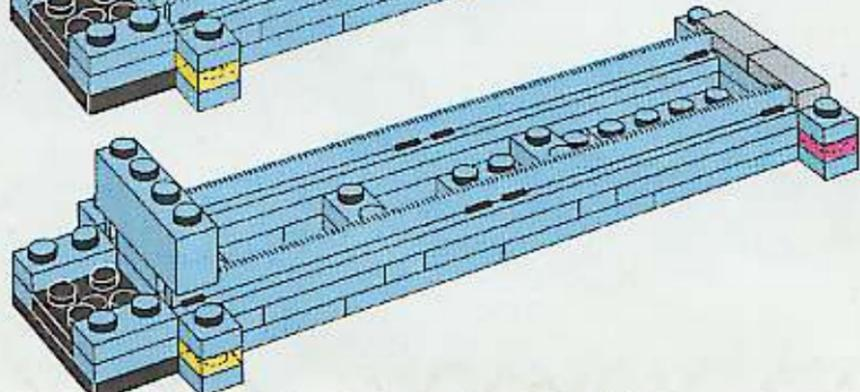

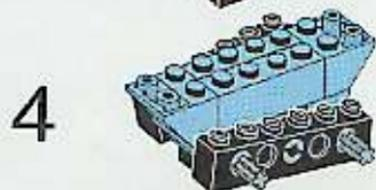
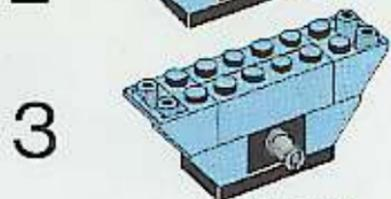
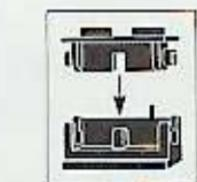

5

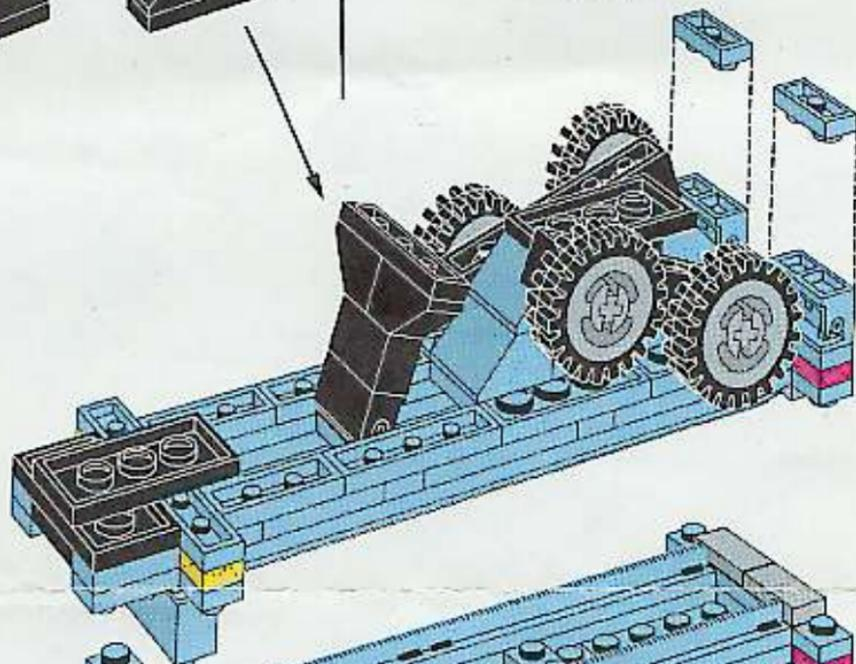

6

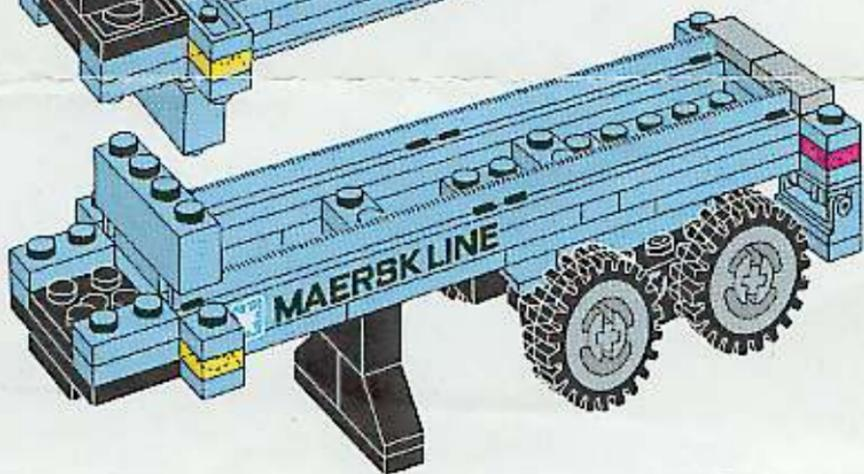

1

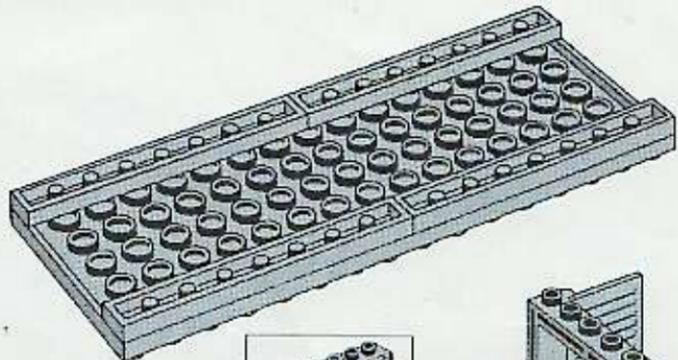

2

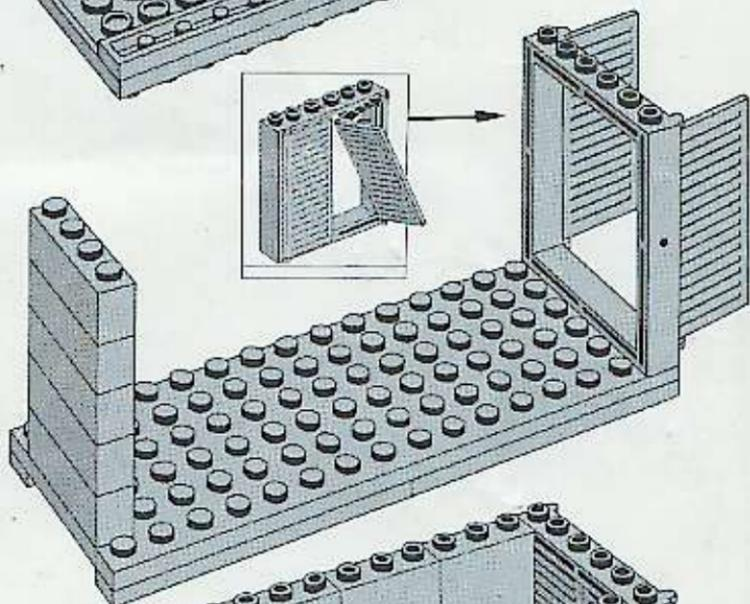

3

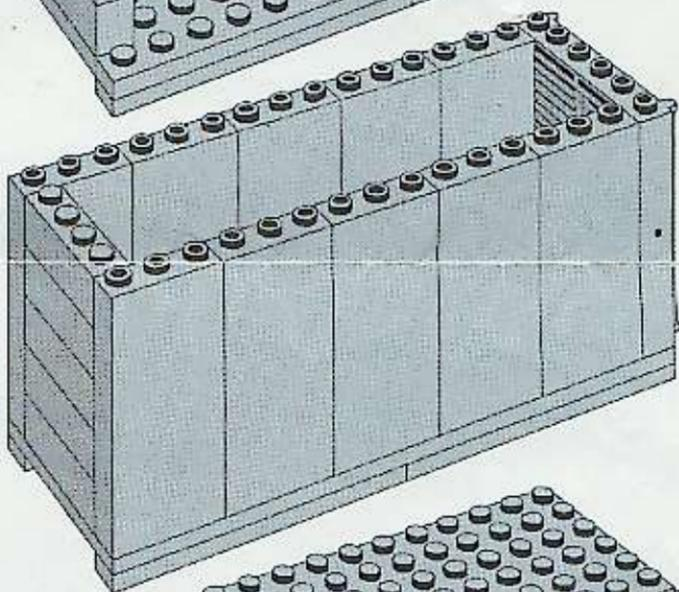

4

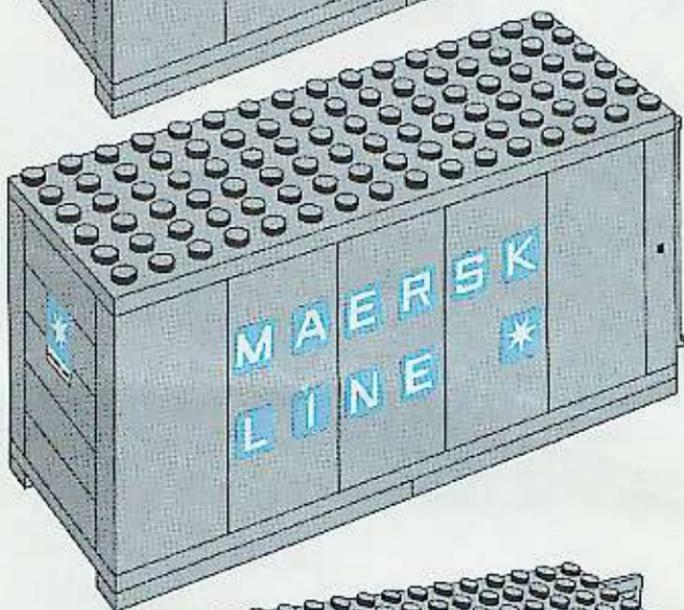

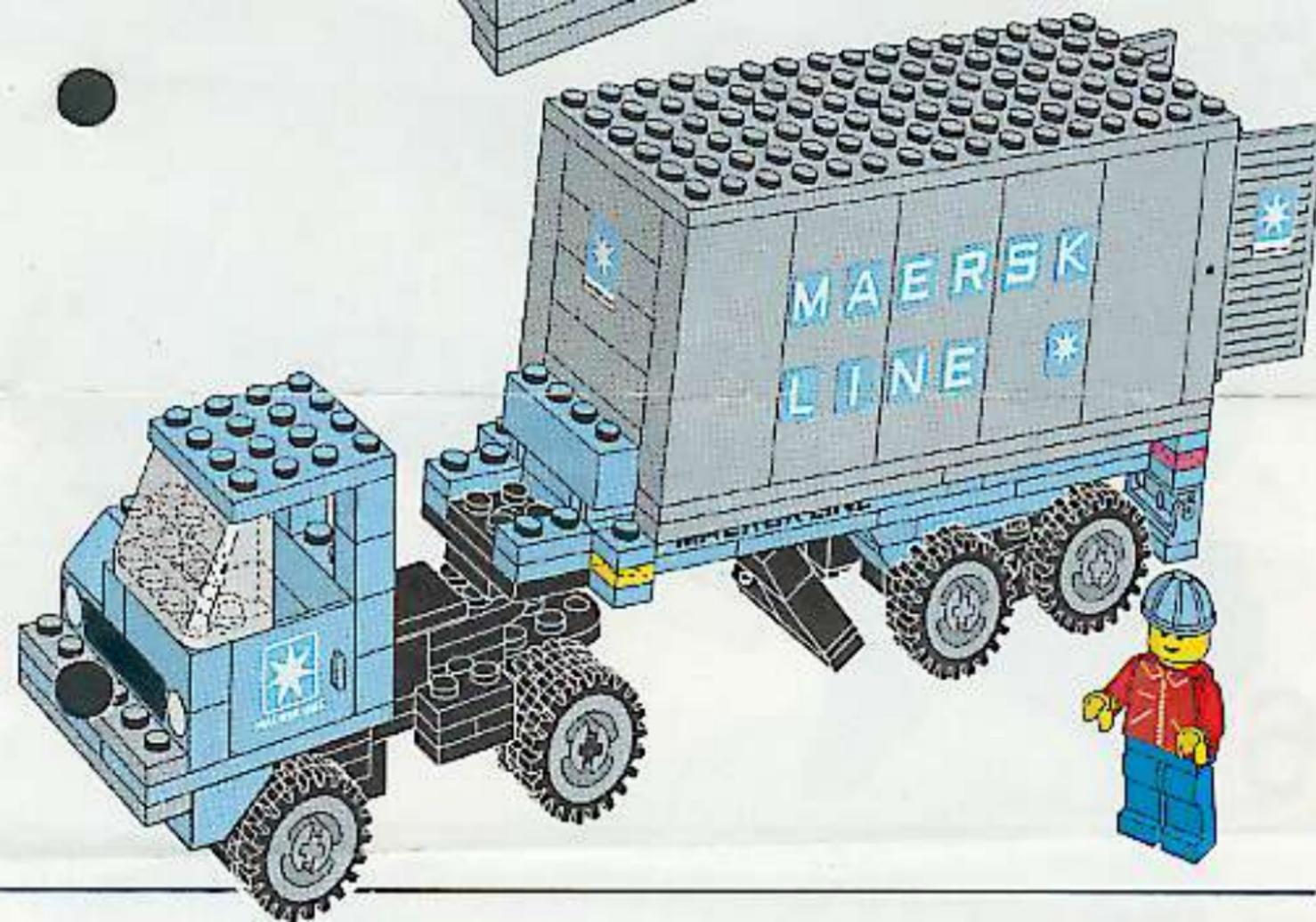

1

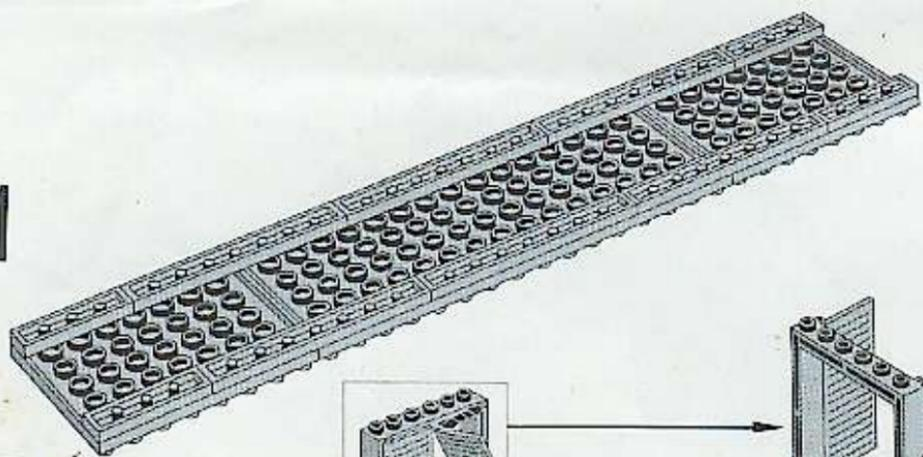

2

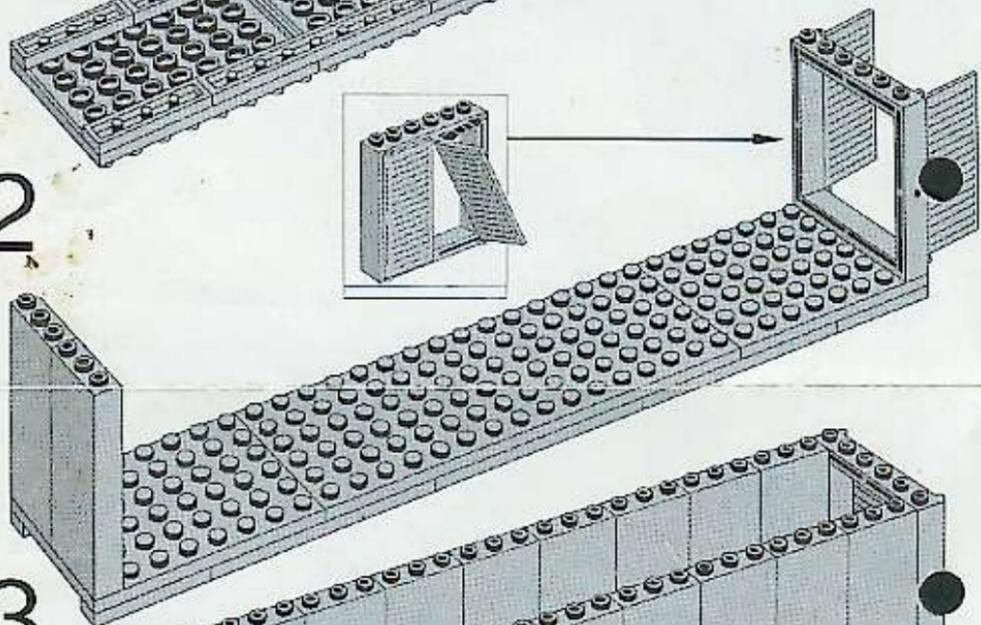

3

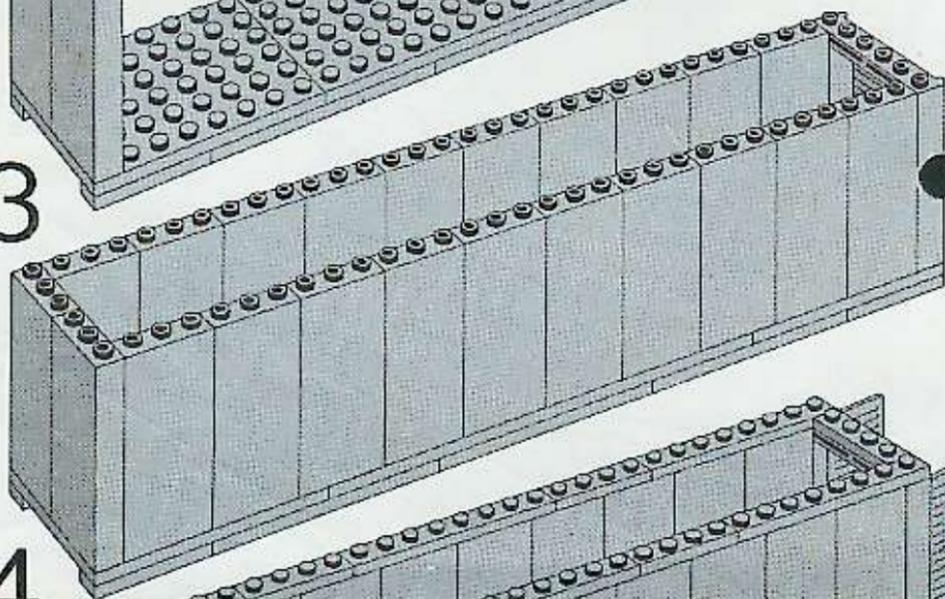

4

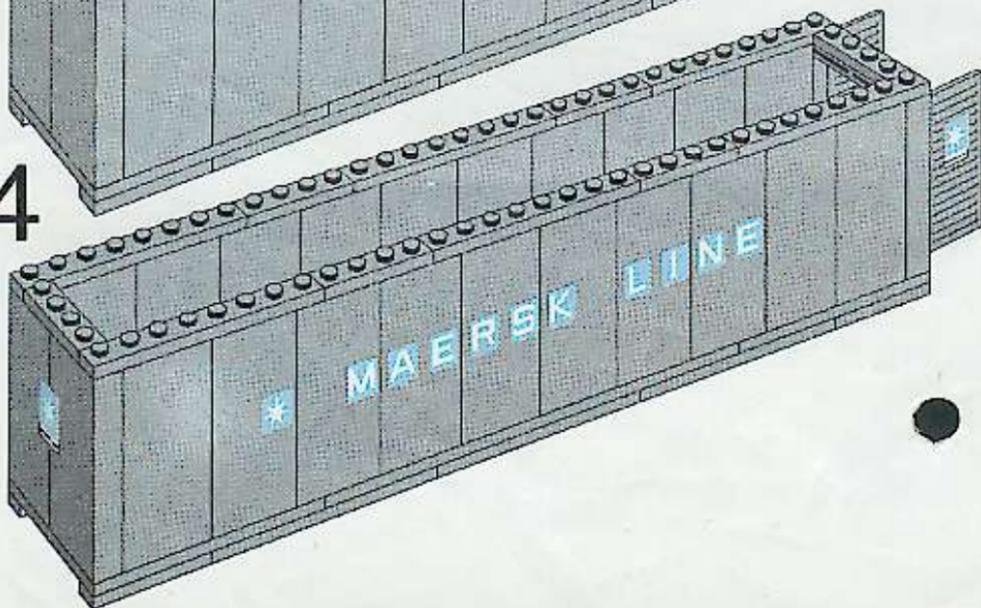

1

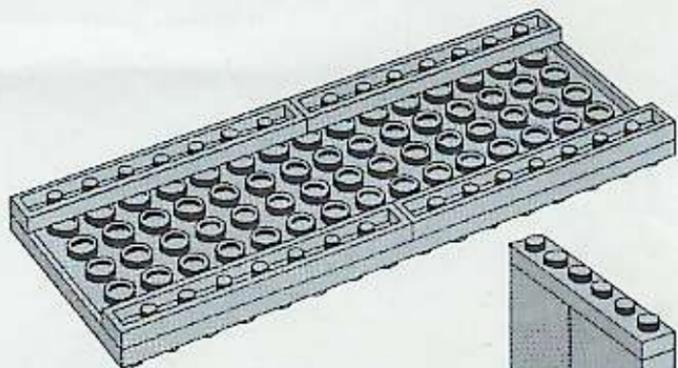

2

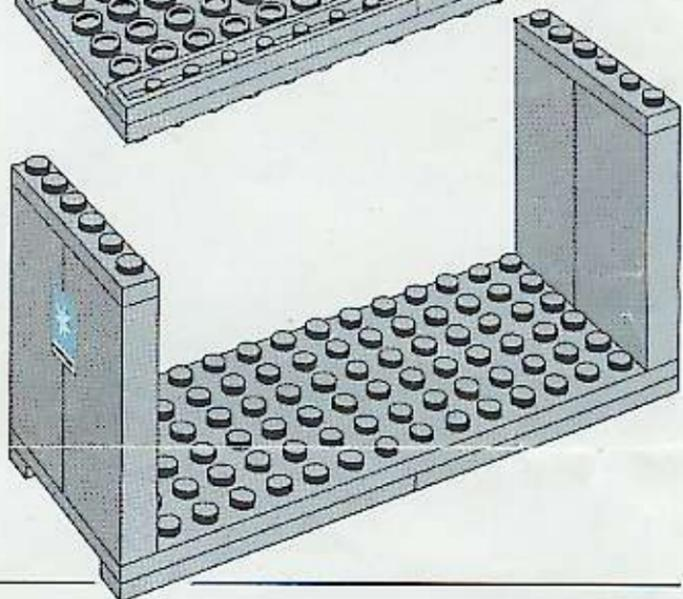

•

1

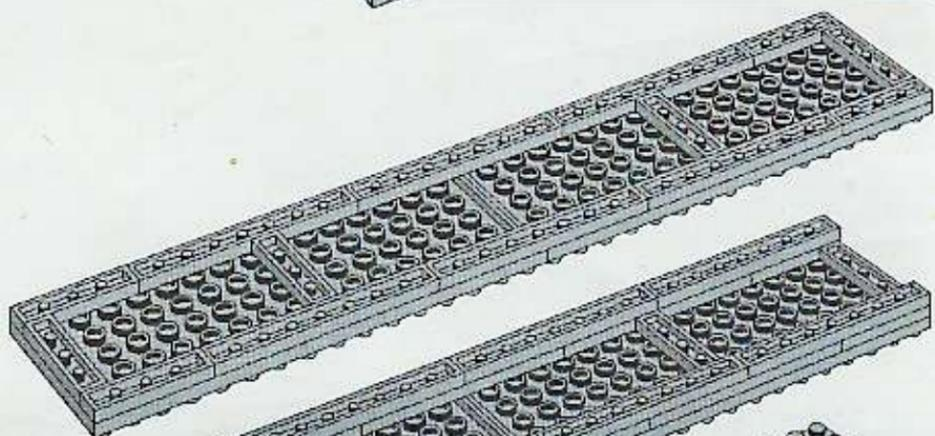

2

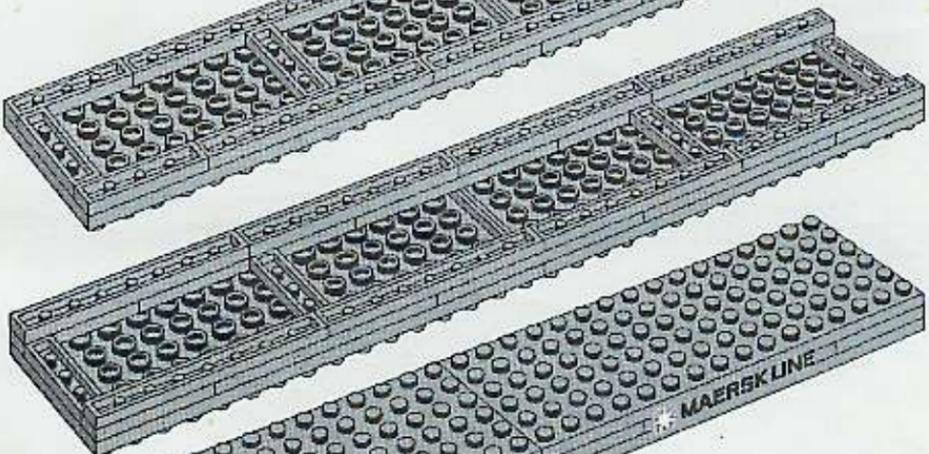

3

